



Refrigerated Sandwich Prep Tables

One, Two and Three Door

Service / Warranty: 888-828-5535

BERS27



BERS36



BERS48



BERS60



BERS72



MODELS: BERS27 BERS36
BERS48 BERS60
BERS72

FEATURES:

- Stainless Steel Exterior & Interior
- Rear Mount Compressor with environmentally friendly R290 refrigerant
- Dixell Digital Controller
- Maintains temperatures between 33°F -40°F
- Pre-installed 1/6 size food pans
- 10" cutting board
- Recessed Door Handle(s)
- Self-Closing door(s) with stay open feature
- Magnetic Door Gasket(s) standard for positive door seal
- One (1) Pre-Installed shelf per section
- Pre-Installed Casters

DIMENSIONS:

	Width	Depth	Height	Net Weight
BERS27	27 ^{1/2}	x 30	x 41 ^{3/8}	159
BERS36	36 ^{3/10}	x 30	x 41 ^{3/8}	173
BERS48	48 ^{1/4}	x 30	x 41 ^{3/8}	231
BERS60	60 ^{1/4}	x 30	x 41 ^{3/8}	271
BERS72	72 ^{11/16}	x 30	x 41 ^{3/8}	317

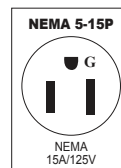

• 2 YEAR PARTS AND LABOR WARRANTY • 5 YEAR COMPRESSOR PART WARRANTY

MD. 12/07/2023



Refrigerated Sandwich Prep Tables

One, Two and Three Door

Service / Warranty: 888-828-5535

SPECIFICATIONS

Model	Doors	Shelves	Cu.Ft	Exterior Dimensions (W x D x H)	Casters	Weight(LBS)	Voltage	HP	Amps	Refrigerant
BERS27	1	1	7.2	27 ^{1/2} × 30 × 41 ^{3/8}	3 inch	196	115/60/1	1/7	2.3	R290
BERS36	2	2	8.68	36 ^{3/10} × 30 × 41 ^{3/8}	2 inch	227	115/60/1	1/7	2.3	R290
BERS48	2	2	13.4	48 ^{1/4} × 30 × 41 ^{3/8}	3 inch	276	115/60/1	1/7	2.3	R290
BERS60	2	2	17.2	60 ^{1/4} × 30 × 41 ^{3/8}	3 inch	320	115/60/1	1/5	2.8	R290
BERS72	3	3	21.1	72 ^{11/16} × 30 × 41 ^{3/8}	3 inch	379	115/60/1	1/5	2.8	R290

LINE DRAWINGS

BERS27

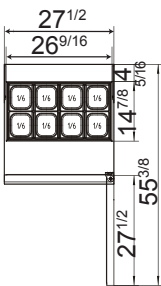

BERS36

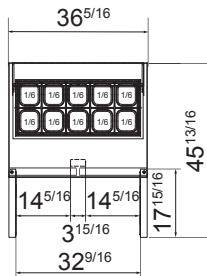

BERS48

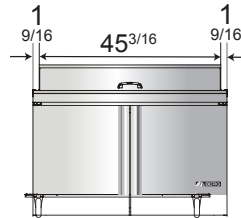
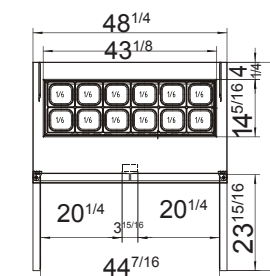

BERS60

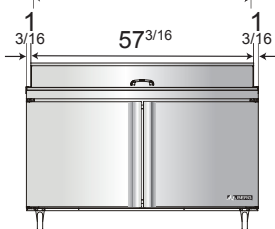
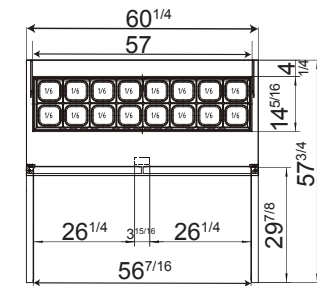

BERS72

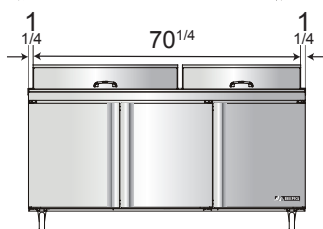
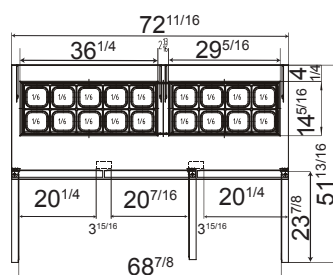

Side View

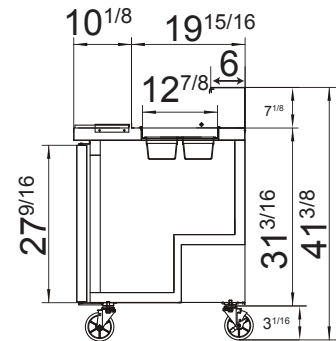

Temperature Control



Epoxy Shelves



Casters



Rear Grate

